







TULLY R SPOT COB - PRO

- FEATURES:**
- Australian designed & manufactured professional low glare accent COB spot light (rear mounted)
 - Adjustable 90° tilt, 359° swivel
 - Specify below surface mount options required
 - 3C track and pendant versions also available
 - Lumen options 980lm up to 1510lm / CRI 80 / CRI 90
 - Requires remote electronic driver
 - Track specify Non-dim / Dali dim / Casambi
 - For **Surface mounted options** specify Non-dim / Phase-cut dim / Dali dim / Casambi
 - Dali - Smart phone Bluetooth connectivity available on request
 - Dali dim 100% - 0.1% option available on request.
 - Casambi Bluetooth wireless mesh control system available on request
 - Serviceable IP20 spotlight
 - Colour temps available: 2700k / 3000k / 4000k
 - Ideal for commercial / hospitality / retail / gallery / museum / residential applications
 - IES files available on request.

COLOURS:

	Black	-2
	White	-3
	White outer / Black inner	-3-2
	Brass outer / Black inner	-tbc
	Bronze outer / Black inner	-tbc
	Silver	-6
	Custom	-5

- ACCESSORIES:**
- Deco glass filter holder (CHL)
 - Frosted glass 30mm (FG)
 - Deco colour glass 50mm (DG)
 - Honeycomb filter (AL20)
 - Lamp droppers 100mm -1500mm (LD)
 - Mited snoot / 140mm UP (TBC)
 - Mited snoot / 140mm Down (TBC)

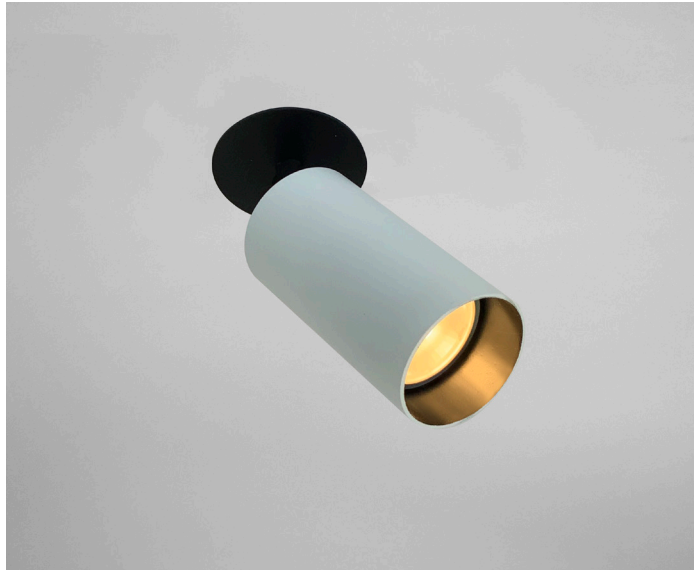

40 DEGREE BEAM ANGLE AS
STANDARD SPEC OPTIONS BELOW

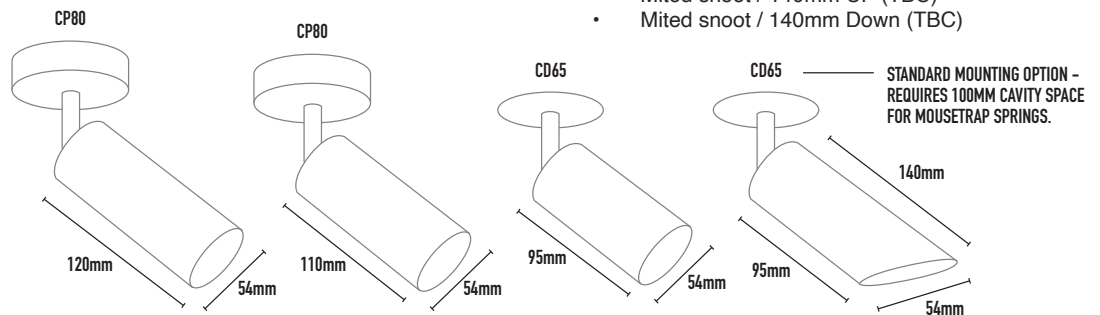
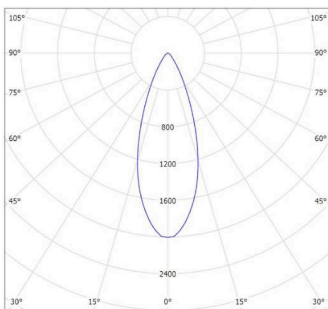

CODE	LAMP TYPE	WATTAGE	LUMENS	COLOUR TEMP	BEAM ANGLE	CRI	mA	DIMENSIONS
TUR500	COB	12.3	980	3000K	15,24,40	90	350	95mm length x 54mm diameter
TUR501	COB	12.3	980	3000K	15,24,40	90	350	110mm length x 54mm diameter
TUR502	COB	12.3	980	3000K	15,24,40	90	350	120mm length x 54mm diameter

PROFESSIONAL

TO SPECIFY ADDITIONAL LED MODULE, "LAMP" OPTIONS: PLEASE SELECT FROM THE CODES BELOW AND ADD TO THE SPECIFICATION

CODE	WATTAGE	LUMENS	COLOUR TEMP	BEAM ANGLE	CRI	MA
MC50-COB-900-927-15D-G1	12.3	980	2700k	15	90	350
MC50-COB-900-927-24D-G1	12.3	960	2700k	24	90	350
MC50-COB-900-927-40D-G1	12.3	920	2700k	40	90	350
MC50-COB-900-930-15D G1	12.3	1040	3000K	15	90	350
MC50-COB-900-930-24D G1	12.3	1020	3000K	24	90	350
MC50-COB-900-930-40D G1	12.3	980	3000K	40	90	350
MC50-COB-900-940-15D G1	12.3	1120	4000K	15	90	350
MC50-COB-900-940-24D G1	12.3	1090	4000K	24	90	350
MC50-COB-900-940-40D G1	12.3	1050	4000K	40	90	350
MC50-COB-1400-930-24D G1	12.9	1430	3000K	24	80	350
MC50-COB-1400-930-40D G1	12.9	1360	3000K	40	80	350
MC50-COB-1400-940-24D G1	12.9	1510	4000K	24	80	350
MC50-COB-1400-940-40D G1	12.9	1430	4000K	40	80	350

- Color consistency Mac Adam Step: 3 (<3SDCM)
- High color rendering performance, CRI 80 and 90 (TM30 compliant) IES TM30

15 DEGREE

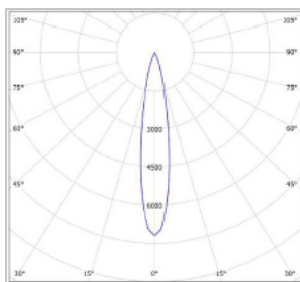

24 DEGREE

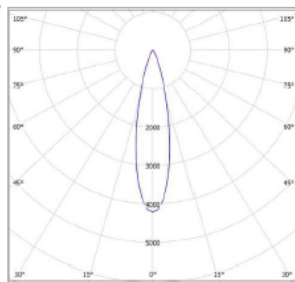

40 DEGREE

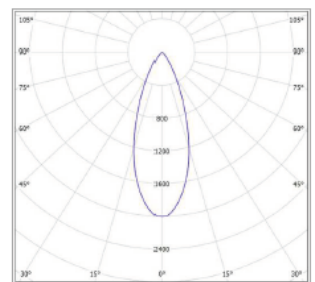

DRIVER OPTIONS:

- OTI / Dali dimmable
- OTE / PhaseCut
- OT / Non dimmable