







# APOLLO

- FEATURES:**
- Australian designed & manufactured
  - Compact 240v interior spotlight
  - Adjustable 90° tilt, 359° swivel
  - Low glare, easy lamp change
  - Suitable for mains track 1C or 3C or with a variety of surface mounted options
  - Ideal for residential, hospitality and commercial applications

**COLOURS:**

	Black	-22
	White	-33
	Silver	-66
	Black outer / Gold inner	-42
	White outer / Gold inner	-43
	White outer / Black inner	-23
	Custom	-5

- ACCESSORIES:**
- Deco glass filter holder (CHL)
  - Frosted glass 30mm (FG)
  - Deco colour glass 50mm (DG)
  - Lamp droppers: 100mm-1500mm (LD)
  - AL 20 HoneyComb filter

- MOUNTING OPTIONS:**
- Additional mounting options available
  - See [Mounting Options](#) spec sheet for more information

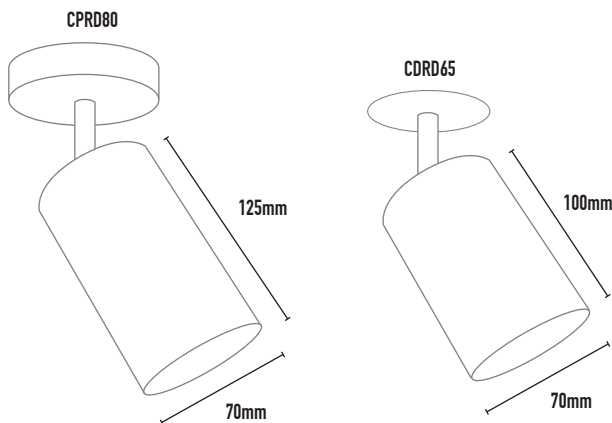

CODE	WATTAGE	LUMENS	LAMP TYPE	DIMENSIONS
APL2125	5W - 10W	380 - 500lm	PAR16 Long GU10 LED	125mm length x 70mm diameter
APL1100	5W - 10W	380 - 500lm	PAR16 Short GU10 LED	100mm length x 70mm diameter