



ARENA LED PENDANT - AL

- FEATURES:**
- Australian designed & manufactured high bay pendant
 - Serviceable Integral electronic control gear and COB LED
 - Anodised spun aluminium high bay reflector / Silver inner
 - Extruded aluminium head and reflector available in a variety of colours
 - 3m suspension standard
 - Lumen options 1800 up to 4780lm / CRI 80 / CRI 90
 - Phase cut dimming standard with COB option.
 - Driver Options: Specify – Dali dim
 - Corridor functionality, daylight harvesting - touch Dim available with Dali
 - Dali dim or Dali dim 100% - 0.1% available on request
 - Dali - smart phone connectivity available on request
 - Casambi bluetooth wireless mesh control system available on request
 - Additional beam angles, colour temp and lower wattage fittings are available on request
 - Colour temps available: 2700k / 3000k / 4000k
 - Serviceable IP20 Pendant
 - E27 version available for residential or hospitality projects
 - Ideal for commercial / universities / schools / showrooms / retail / and hospitality applications
 - IES files available on request

TRIM COLOURS: Inner standard as silver

	Black	-2
	White	-3
	Silver	-6
	Custom	-5



60 DEGREE

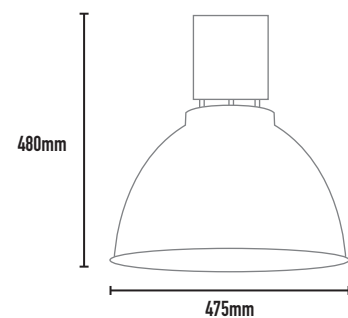
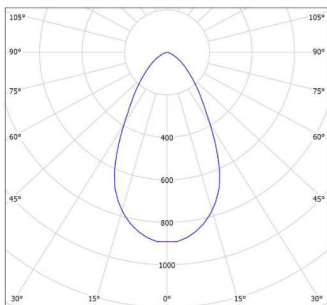

CODE	LAMP TYPE	WATTAGE	LUMENS	COLOUR TEMP	BEAM ANGLE	CRI	MA	DIMENSIONS
AHB6413	COB	37.6	4240	3000k	60°	80	1050	480mm x 475mm diameter
AHB6414	COB	37.6	4450	4000k	60°	80	1050	480mm x 475mm diameter
AHB21	E27 MAX 100W	NON-VARIOUS / SPECIFY		SPECIFY				480mm x 475mm diameter

PROFESSIONAL

TO SPECIFY ADDITIONAL LED MODULE, "LAMP" OPTIONS: PLEASE SELECT FROM THE CODES BELOW AND ADD TO THE SPECIFICATION

CODE	WATTAGE	LUMENS	COLOUR TEMP	BEAM ANGLE	CRI	MA
MC111-COB-1800-927-15D-G1	18	1730	2700	15	90	500
MC111-COB-1800-927-24D-G1	18	1770	2700	24	90	500
MC111-COB-1800-927-40D-G1	18	1770	2700	40	90	500
MC111-COB-1800-930-15D-G1	18	1840	3000	15	90	500
MC111-COB-1800-930-24D-G1	18	1880	3000	24	90	500
MC111-COB-1800-930-40D-G1	18	1800	3000	40	90	500
MC111-COB-1800-940-15D-G1	18	1940	4000	15	90	500
MC111-COB-1800-940-24D-G1	18	1990	4000	24	90	500
MC111-COB-1800-940-40D-G1	18	1910	4000	40	80	500
MC111-COB-2800-830-15D-G1	25.9	2700	3000	15	80	700
MC111-COB-2800-830-24D-G1	25.9	2760	3000	24	80	700
MC111-COB-2800-830-40D-G1	25.9	2650	3000	40	80	700
MC111-COB-2800-840-15D-G1	25.9	2830	4000	15	80	700
MC111-COB-2800-840-24D-G1	25.9	2900	4000	24	80	700
MC111-COB-2800-840-40D-G1	25.9	2780	4000	40	80	700
MC111-COB-4300-830-24D-G1	37.6	4550	3000	24	80	1050
MC111-COB-4300-830-40D-G1	37.6	4340	3000	40	80	1050
MC111-COB-4300-830-60D-G1	37.6	4240	3000	60	80	1050
MC111-COB-4300-840-24D-G1	37.6	4780	4000	24	80	1050
MC111-COB-4300-840-40D-G1	37.6	4560	4000	40	80	1050
MC111-COB-4300-840-60D-G1	37.6	4450	4000	60	80	1050

- Color consistency Mac Adam Step: 3 (<3SDCM)
- High color rendering performance, CRI 80 and 90 (TM30 compliant) IES TM30

15 DEGREE

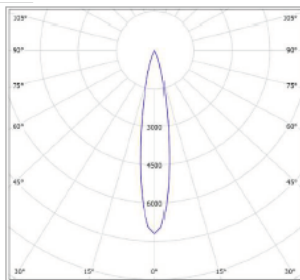

24 DEGREE

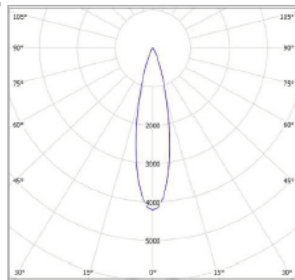

40 DEGREE

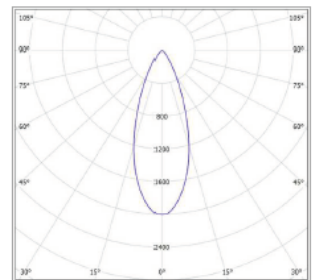

DRIVER OPTIONS:

- OTI / Dali dimmable
- OTE / PhaseCut
- OT / Non dimmable